

EC 前倾离心及鼓风机
EC Forward Curved Centrifugal Fan and Blower

ErP2015
EXCEEDS THE NORM



Φ 180

转子材质 Rotor Material: 碳钢 Carbon steel
 蜗壳材质 Housing Material: 碳钢 Carbon steel
 叶轮材质 Impeller Material: 镀锌板 Galvanized steel sheet
 防护等级 Ingress Protection: IP44
 绝缘等级 Insulation Class: F
 轴承类型 Bearing Type: 免维护滚珠轴承
 Maintenance free ball bearing

性能曲线 Performance Curves

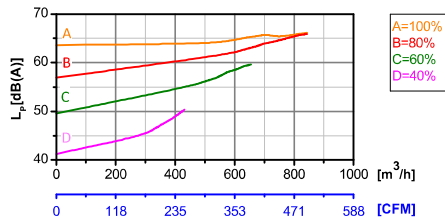
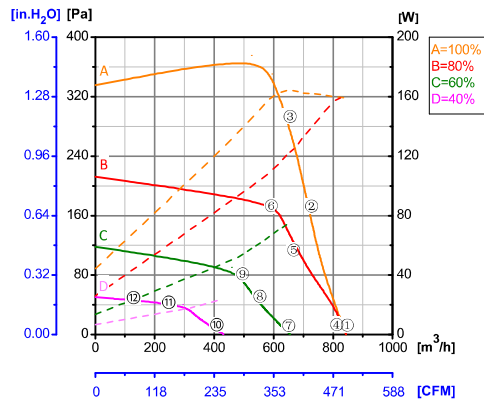

测试节点 Test Point	转速 Speed rpm	输入功率 Input Power W
1	1538	159
2	1750	162
3	1888	164
4	1540	159
5	1595	133
6	1595	116
7	1199	75
8	1198	62
9	1198	55
10	799	24
11	797	20
12	797	17

Erp2015 Data:
 Efficiency η_{statA} = 33.9%
 Efficiency grade N_{actual} = 45.8, N_{target} = 44
 Test report No. : L-20210302-003-033

产品型号 Model No.	电压 Voltage	频率 Frequency	转速 Speed	输入功率 Input Power	电流 Current	运行温度 Working Temp.	认证 Approvals
	VAC	Hz	RPM	W	A	Min/Max (°C)	
EC92-F180-030	1~220/230	50/60	1520	165	1.23	-20/+60	CCC,CE,UL

前倾离心风机 Motorized Forward Curved Impeller

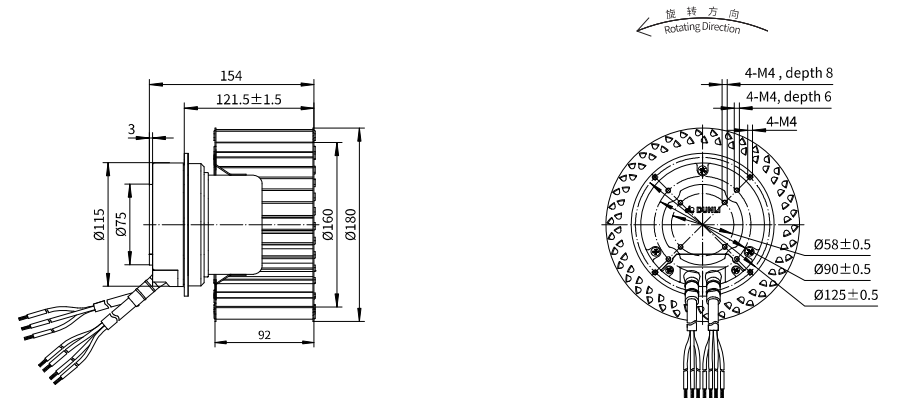

鼓风机 Blower

